

Article number: 2301044501
 Description: E+G Crank handle
 MT.160-A16

Measures

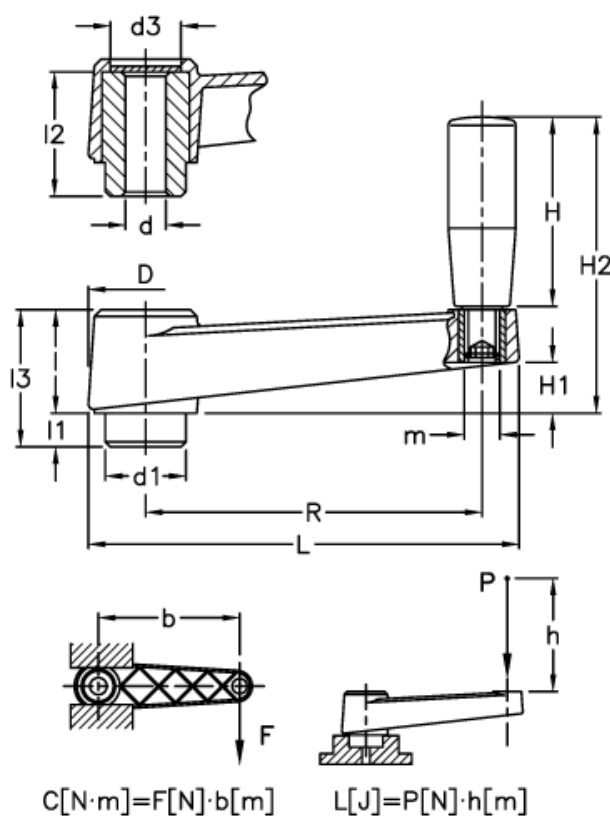

C (N m) = 450	l = 40
D = 45	L = 198
d1 = 34	L (J) = 55
d3 = 27	l1 = 15
d H7 = 16	l2 = 49
H = 90	l3 = 55
H1 = 23	m = M10
H2 = 130	R = 160